

T系列螺旋锥齿轮转向箱

T series bevel gear units

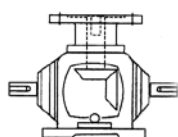

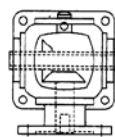
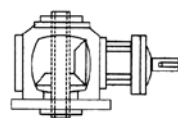
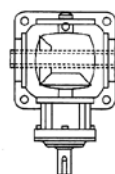
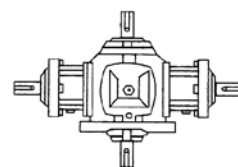
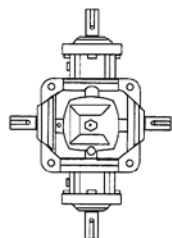
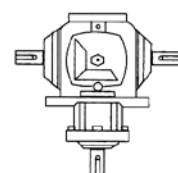
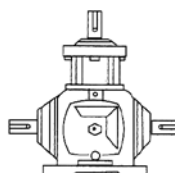
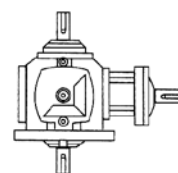
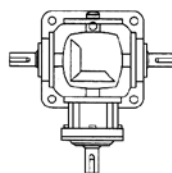
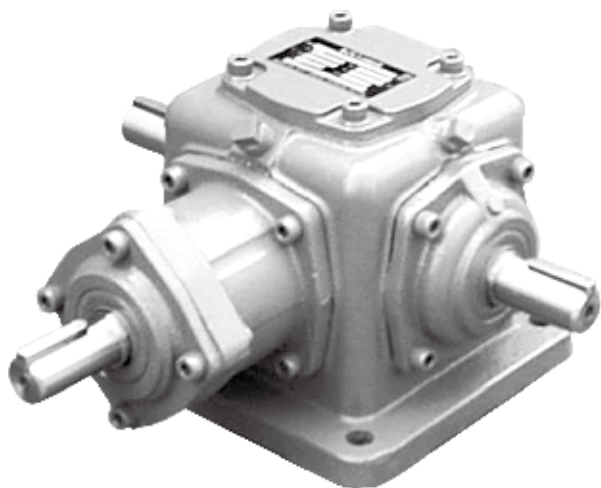
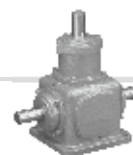

1. T系列螺旋锥齿轮传动箱概述

1.1 T系列一级螺旋锥齿轮传动箱,标准化,多品种,速比1:1、1.5:1、2:1、2.5:1、3:1、4:1、5:1,全部为实际传动比,平均效率98%。

1.2 有单轴、双横轴、单纵轴、双纵轴可选。

1. T series spiral bevel gearbox overview

1.1 T series spiral bevel gearbox, production standardization, multi-variety, ratio of 1:1, 1.5:1, 2:1, 2.5:1, 3:1, 4:1 and 5:1, they are normal ratio. Average efficiency 98%.

1.2 There are one input shaft, two input shafts, unilateral output shaft and double side output shaft.

1.3 Spiral bevel gear are both position and reverse rotation, low speed or high speed operate stably and noise low, vibration gently carrying larger force.

2. T系列结构图

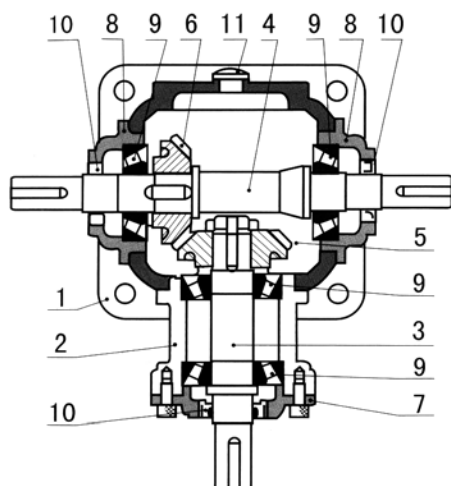

2. T series structure drawing

- | | |
|---------|------------------------------|
| 1、机座 | Housing |
| 2、横轴座 | Housing of input shaft |
| 3、横轴 | Input shaft |
| 4、纵轴 | Output shaft |
| 5、横轴锥齿轮 | Drive spiral bevel gear |
| 6、纵轴锥齿轮 | Driven spiral bevel gear |
| 7、端盖 | Bearing seat of input shaft |
| 8、端盖 | Bearing seat of output shaft |
| 9、轴承 | Bearing |
| 10、油封 | Seal |
| 11、油镜 | Oil gauge |

3. 转向功能

3. Function of rotation

1 横轴 Input shaft		2 横轴 Input shaft	
2轴 2-extended shaft	3轴 3-extended shaft	3轴 3-extended shaft	4轴 4-extended shaft

说明: 当输入轴旋转方向改变, 输出轴相应改变。

Specification: Direction of rotation of output shaft varies with that of input shaft.

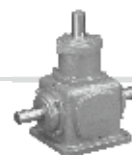

4. 选定输入轴式应注意转速关系 (1:1传动比时无关系)

4. Please pay attention to speed relationship when selecting input shaft (there is nothing in case of ratio of 1:1)

例：速比为2:1时

Example: when ratio is 2

[减速Reducing]	[增速Increasing]
<p>当横轴输入100r/min时, 纵轴输出50r/min Output speed is 50rpm, when input speed is 100rpm</p>	<p>当纵轴输入100r/min时, 横轴输出200r/min Output speed is 200rpm, when input speed is 100rpm</p>

5. 应用实例

5. Application example

<p>并排转送 Transmission in series</p> <p>给纵轴连结送力,使横轴同步运转</p>		<p>升降装置 Elevating gear</p> <p>1台减速机左右输出,通过转向后,同时升降</p>
<p>立体车库 Tridimensional car barn</p> <p>1台减速机驱动左右链轮同步运转。 One reducer drive right and left chain wheel and rotate at the same speed.</p>	<p>游戏机 Play machine</p> <p>纵轴输入, 2横轴相反运转</p>	<p>包装机 Packing machine</p>

6. 型号表示方法

6. T series model expressing example

T6	—	1:1	—	RA4	—	B₃
机座号 Size of gear units		速比 Ratio		轴配置 Shaft arrangement		安装方位 Mounting position
T8	—	2:1	—	RE1	—	B₈
机座号 Size of gear units		速比 Ratio		轴配置 Shaft arrangement		安装方位 Mounting position



7. T系列重量表

7. T series weight table

Type	T2	T4	T6	T7	T8	T10	T12	T16	T20	T25
m(kg)	2	10	21	32	49	78	124	188	297	488

8. T系列Fr(N)表

8. T series Fr(N) table

i _N	n ₁ (r/min)	T2		T4		T6		T7		T8		T10		T12		T16		T20		T25	
		横轴	纵轴	横轴	纵轴	横轴	纵轴	横轴	纵轴	横轴	纵轴	横轴	纵轴	横轴	纵轴	横轴	纵轴	横轴	纵轴	横轴	纵轴
1:1	1450	265	216	833	951	1911	2450	2450	3136	3234	3381	4165	4508	5096	5586	10633	10976				
	1150	323	235	882	1029	2058	2597	2744	3234	3479	3626	4459	4851	5488	6076	11368	11760	15386	15608		
	870	402	255	960	1127	2205	2842	2989	3381	3773	3969	4851	5292	5880	6566	12446	12740	16660	17150	24794	25480
	580	549	314	1078	1323	2499	3185	3381	3822	4263	4459	5488	5880	6713	7301	14014	14504	18816	19404	28028	28910
	400	637	353	1372	1715	3185	3528	4018	4900	4851	5978	6272	7056	7742	8134	15680	16170	21070	21756	31360	32340
	300	696	392	1519	1960	3430	3528	4410	5537	5243	6958	6713	7987	8232	9065	17150	17640	23422	24108	34300	35280
	200	784	441	1911	190	3430	3528	5096	6272	7889	8820	8575	9604	9261	10290	19600	19894	25970	26754	38612	39788
	100	980	588	1911	1960	3430	3528	5096	6272	8428	8820	9996	11760	11368	12593	22540	22540	28420	32928	39200	49000
	10	980	588	1911	1960	3430	3528	5096	6272	8428	8820	9996	11760	11858	14504	22540	22540	28420	33320	39200	49000
1.5:1	1450			1078	1960	2548	2842	3430	5390	4361	7987	5194	9212	5978	10486	5978	12152	7693	14602		
	1150			1078	1960	3038	3087	4067	5978	5096	8820	6174	10486	7252	12152	6419	13083	8771	17934	12985	24647
	870			1078	1960	3430	3332	4753	6076	6076	8820	7448	11760	8869	14504	6958	14210	9506	19453	13573	29400
2:1	580			1078	1960	3430	3528	5096	6174	7644	8820	9555	11760	11466	14504	7840	16072	10780	22001	15680	33222
	400			1078	1960	3430	3528	5096	6272	8428	8820	9996	11760	11858	14504	8820	17934	12005	24598	17542	37142
2.5:1	300			1078	1960	3430	3528	5096	6272	8428	8820	9996	11760	11858	14504	9604	19600	13132	27342	19159	40474
	200			1078	1960	3430	3528	5096	6272	8428	8820	9996	11760	11858	14504	10829	22148	14798	30282	21658	45766
3:1	100			1078	1960	3430	3528	5096	6272	8428	8820	9996	11760	11858	14504	13328	22540	18228	33320	26656	49000
	10			1078	1960	3430	3528	5096	6272	8428	8820	9996	11760	11858	14504	22540	22540	28420	33320	39200	49000

备注:各规格更低的输出转速按以上最大的Fr值。

Notes: If there is lower output speed, please choose the maximum Fr in above table.

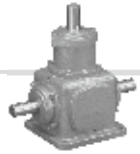

9. T系列举例

9. T series selection sample

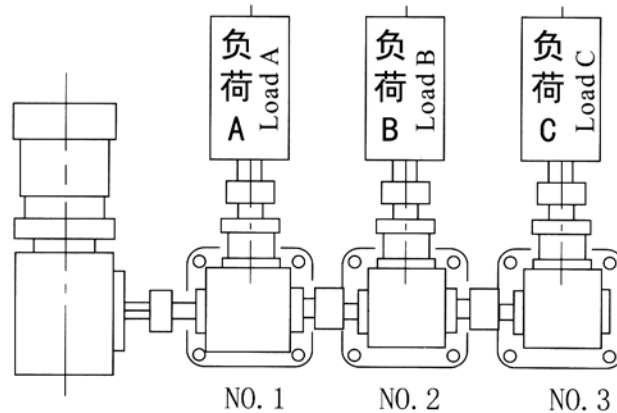

3台负载全部为 $196\text{N}\cdot\text{m}$ ，一般冲击，每天连续工作8小时，即使用系数 $f_s=1.25$ ，斜齿轮输入轴转速以 $300\text{r}/\text{min}$ ，速比全部为1:1。

根据公式：

每台齿轮箱本身所需的负载 $MN_2 \geq M_2 \times f_s = 196 \times 1.25 = 245\text{N}\cdot\text{m}$

- 1号齿轮箱 因1号齿轮箱本身的负载为 $245\text{N}\cdot\text{m}$ ，而2号、3号齿轮箱需通过1号齿轮箱体传递扭矩。所以1号齿轮箱应承担的负载为： $245\text{N}\cdot\text{m} + 245\text{N}\cdot\text{m} + 245\text{N}\cdot\text{m} = 735\text{N}\cdot\text{m}$ ，依据传动能力表，应选T12。
- 2号齿轮箱 除本身的负载 $245\text{N}\cdot\text{m}$ ，还需传递3号齿轮箱的扭矩。所以总负载应为 $245\text{N}\cdot\text{m} + 245\text{N}\cdot\text{m} = 490\text{N}\cdot\text{m}$ ，依据传动能力表，应选T10。
- 3号齿轮箱 由于仅一个负载C进行运转，即所需负载在 $245\text{N}\cdot\text{m}$ 以上即可，依据传动能力表可选T8。

Torque values of three gearboxes are 196Nm , uniform, operate continuous for 8 hour per day, that is, useful factor $f_s=1.25$, input speed of 300rpm , ratio of 1:1.

Calculate according to formula:

Required torque of any of gearbox MN_2 is equal to 245Nm or larger.

- No.1 gearbox No.1 gearbox carry torque 245Nm , but No.2 and No.3 gearbox need transfer torque through No.1, Consequently No.1 gearbox should carry torque 735 Nm ($245\text{Nm}+245\text{Nm}+245\text{Nm}$), select T12 according to transmission capacity table.
- No.2 gearbox No.3 gearbox still transfers torque of No.3 gearbox besides touque of 245 Nm , so, the total torque is 490Nm ($245\text{Nm}+245\text{Nm}$), select T10 according to transmission capacity table.
- No.3 gearbox Required torque is more than 245 Nm because of only load C according to transmission capacity table.



10. T系列传动能力表

10. T series transmission capacity table

i	n ₁ (r/min)	T2		T4		T6		T7		T8	
		M _{N2} (N·m)	P _{N1} (kW)	M _{N2} (N·m)	P _{N1} (kW)	M _{N2} (N·m)	P _{N1} (kW)	M _{N2} (N·m)	P _{N1} (kW)	M _{N2} (N·m)	P _{N1} (kW)
1:1	1450	11.6	1.79	31.9	4.94	96.0	14.9	142	22.0	294	45.6
	1150	11.7	1.43	34.1	4.19	103	12.7	150	18.4	305	37.5
	870	12.1	1.12	37.2	3.46	113	10.5	164	15.2	312	29.0
	580	12.1	0.747	39.5	2.45	119	7.35	184	11.4	319	19.8
	400	12.3	1.524	40.2	1.72	122	5.20	195	8.34	326	14.0
	300	12.3	0.396	40.5	1.30	123	3.93	198	6.35	331	10.6
	200	12.4	0.226	41.2	0.880	124	2.66	201	4.30	338	7.23
	100	12.7	0.136	41.9	0.448	127	1.36	206	2.20	346	3.70
10	13.0	0.014	43.0	0.046	132	0.141	214	0.228	361	0.386	
1.5:1	1450					117	12.1	145	15.0	185	19.1
	1150					122	9.96	147	12.0	188	15.4
	870					123	7.66	150	9.30	191	11.8
	580					126	5.23	153	6.32	197	8.14
	400					128	3.66	155	4.41	200	5.70
	300					129	2.77	157	3.35	203	4.34
	200					131	1.87	160	2.28	204	2.91
	100					134	0.957	163	1.16	210	1.49
10					139	0.099	169	0.12	218	0.155	
2:1	1450	12.1	0.94	42.8	3.32	102	7.90	137	10.6	180	14.0
	1150	12	0.74	43.4	2.67	104	6.39	139	8.55	183	11.3
	870	12	0.56	43.8	2.04	105	4.88	141	6.56	187	8.70
	580	11.9	0.37	44.4	1.38	108	3.34	144	4.47	191	5.92
	400	12.2	0.26	45.1	0.96	109	2.33	146	3.12	194	4.15
	300	11.9	0.19	45.5	0.73	110	1.76	148	2.37	196	3.14
	200	12.2	0.13	46.1	0.49	111	1.18	149	1.59	198	2.12
	100	11.2	0.06	46.6	0.25	114	0.608	152	0.812	202	1.08
10	28.1	0.015	48.5	0.026	116	0.062	157	0.084	209	0.112	
2.5:1	1450					96.2	5.97	113	6.99	184	11.4
	1150					97.2	4.78	115	5.64	185	9.11
	870					99.0	3.68	116	4.30	188	7.00
	580					100.0	2.48	118	2.92	192	4.76
	400					100.9	1.73	120	2.05	195	3.34
	300					102.9	1.32	121	1.55	197	2.53
	200					103.9	0.888	123	1.05	200	1.71
	100					104.9	0.448	123	0.528	203	0.867
10					107.8	0.046	126	0.054	208	0.089	
3:1	1450					93.6	4.84	105	5.42	159	8.20
	1150					94.8	3.88	106	4.34	160	6.55
	870					95.9	2.97	108	3.34	163	5.04
	580					97.6	2.02	109	2.25	166	3.42
	400					99.0	1.41	111	1.58	168	2.39
	300					100	1.07	111	1.18	169	1.80
	200					100	0.712	113	0.803	171	1.22
	100					102	0.363	115	0.409	173	0.618
10					104	0.037	118	0.042	179	0.064	
4:1	1450					80.6	3.12	93.4	3.62	124	4.80
	1150					81.5	2.50	94.3	2.90	125	3.83
	870					82.4	1.92	95.9	2.23	127	2.95
	580					84.1	1.30	96.9	1.50	129	2.00
	400					85.1	0.91	98.7	1.05	131	1.40
	300					86.1	0.69	98.3	0.79	131	1.05
	200					86.0	0.46	101	0.54	134	0.71
	100					87.7	0.23	101	0.27	135	0.36
10					89.3	0.02	101	0.03	140	0.04	
5:1	1450					52.0	1.61	57.4	1.78	68.7	2.13
	1150					52.5	1.29	58.0	1.43	69.2	1.70
	870					53.2	0.99	59.0	1.10	70.4	1.31
	580					54.2	0.67	59.6	0.74	71.7	0.89
	400					54.9	0.47	60.7	0.52	72.6	0.62
	300					55.5	0.36	60.4	0.39	72.9	0.47
	200					55.4	0.24	61.7	0.26	74.1	0.32
	100					56.5	0.12	62.9	0.13	75.1	0.16
10					57.6	0.01	64.5	0.01	77.8	0.02	

1.横轴转速未达到10r/min时, 请使用10r/min的数据。

2. 以上有灰色标识的规格订货时需咨询, 横后输入转速超过1450r/min时, 向本公司咨询。



i	n ₁ (r/min)	T10		T12		T16		T20		T25	
		M _{N2} (N·m)	P _{N1} (kW)	M _{N2} (N·m)	P _{N1} (kW)	M _{N2} (N·m)	P _{N1} (kW)	M _{N2} (N·m)	P _{N1} (kW)	M _{N2} (N·m)	P _{N1} (kW)
1:1	1450	421	65.3	619	96.0	1019	163				
	1150	453	55.7	665	81.1	1098	139	1842	234		
	870	479	44.6	726	67.5	1186	114	2009	193	3489	335
	580	493	30.6	802	49.7	1343	85.9	2274	145	3940	252
	400	504	21.5	821	35.1	1499	66.1	2538	112	4410	195
	300	513	16.4	835	26.8	1637	54.1	2744	90.8	4792	159
	200	521	11.1	852	18.2	1784	39.3	3126	69.0	5390	119
	100	535	5.72	875	9.36	1842	20.3	3205	35.3	5439	60.0
10	561	0.599	919	0.983	1940	2.14	3205	3.53	5713	6.30	
1.5:1	1450	374	38.7	564	58.3						
	1150	380	31.2	601	49.2						
	870	389	24.1	656	40.7						
	580	396	16.4	699	28.9						
	400	406	11.6	711	20.3						
	300	411	8.78	724	15.5						
	200	417	5.95	736	10.5						
	100	426	3.04	754	5.37						
10	443	0.316	785	0.56							
2:1	1450	305	23.6	516	40.0	921	73.7	1578	126		
	1150	309	19.0	516	31.7	938	59.5	1607	102	3146	199
	870	315	14.6	516	24.0	958	46.0	1646	79.0	3224	155
	580	322	10.0	524	16.3	980	31.3	1695	54.2	3332	107
	400	328	7.02	538	11.5	1000	22.0	1725	38.0	3420	75.4
	300	332	5.33	543	8.71	1009	16.7	1754	29.0	3479	57.5
	200	338	3.61	551	5.89	1029	11.3	1784	19.7	3557	39.2
	100	344	1.84	563	3.01	1058	5.84	1833	10.1	3646	20.1
10	357	0.191	586	0.313	1098	0.605	1921	1.06	3822	2.11	
2.5:1	1450	293	18.2	507	31.4						
	1150	298	14.7	514	25.3						
	870	302	11.2	523	19.5						
	580	310	7.68	535	13.3						
	400	315	5.38	545	9.32						
	300	317	4.06	552	7.08						
	200	321	2.75	560	4.79						
	100	326	1.40	568	2.43						
10	336	0.144	588	0.251							
3:1	1450	270	14.0	458	23.6	904	48.2	1529	82.3	2935	158
	1150	275	11.3	464	19.0	920	38.9	1561	66.6	3045	130
	870	279	8.66	469	14.6	940	30.1	1598	51.6	3135	101
	580	285	5.89	480	9.92	960	20.4	1644	35.4	3246	69.9
	400	288	4.11	490	6.98	978	14.4	1672	24.8	3317	49.3
	300	291	3.11	495	5.29	990	10.9	1701	18.9	3372	37.6
	200	294	2.10	501	3.57	1005	7.38	1733	12.9	3449	25.6
	100	300	1.07	510	1.82	1038	3.82	1777	6.60	3537	13.1
10	308	0.110	527	0.188	1076	0.40	1865	0.69	3713	1.4	
4:1	1450	241	9.35	434	16.8	850	34.3	1452	58.7	2798	113
	1150	246	7.54	441	13.5	865	27.7	1483	47.5	2892	92.6
	870	249	5.78	448	10.4	884	21.4	1518	36.8	2978	72.2
	580	254	3.93	456	7.07	902	14.6	1562	25.2	3084	49.8
	400	257	2.74	465	4.97	919	10.2	1588	17.7	3151	35.1
	300	259	2.08	470	3.77	930	7.8	1616	13.5	3204	26.8
	200	262	1.40	476	2.54	944	5.3	1646	9.17	3276	18.2
	100	267	0.71	485	1.30	976	2.7	1688	4.70	3360	9.36
10	275	0.07	501	0.13	1011	0.3	1772	0.49	3527	0.98	
5:1	1450	136	4.21	296	9.18	814	26.3	1391	44.9	2631	85.0
	1150	138	3.39	301	7.39	828	21.2	1420	36.4	2771	71.0
	870	140	2.60	305	5.68	847	16.4	1454	28.2	2853	55.3
	580	143	1.77	311	3.86	864	11.2	1496	19.3	2954	38.2
	400	144	1.23	318	2.72	881	7.85	1521	13.6	3018	26.9
	300	146	0.93	321	2.06	891	5.96	1548	10.3	3069	20.5
	200	148	0.63	325	1.39	905	4.03	1577	7.03	3138	14.0
	100	150	0.32	331	0.71	935	2.08	1617	3.60	3218	7.17
10	155	0.03	342	0.07	969	0.22	1697	0.38	3378	0.75	

1. If speed is less than 10rpm, please choose 10rpm.

2. Please contact us, when order the model with gray sign or that input speed is more than 1450rpm.



11. 轴配置及轴旋转方向的关系、安装方位及尺寸图表

11. The relationship between shaft arrangements and direction of shaft rotation, mounting position and dimension sheets T2-T16

RA1	RA2	RA3	B3	B6	V5
RA4	RA5	RA6	B8	B7	V6
RB1	RB2	RB3	B3	B6	V5
RB4	RB5	RB6	B8	B7	V6
RC1	RC2	RC3	B3	B6	V5
RC4	RC5	RC6	B8	B7	V6
RD1	RD2	RD3	B3	B6	V5
RD4	RD5	RD6	B8	B7	V6
RE1	RE2	RE3	B3	B6	V5
RE4	RE5	RE6	B8	B7	V6
RF1	RF2	RF3	B3	B6	V5
RF4	RF5	RF6	B8	B7	V6



11. 轴配置及轴旋转方向的关系、安装方位及尺寸图表

11. The relationship between shaft arrangements and direction of shaft rotation, mounting position and dimension sheets T2-T16

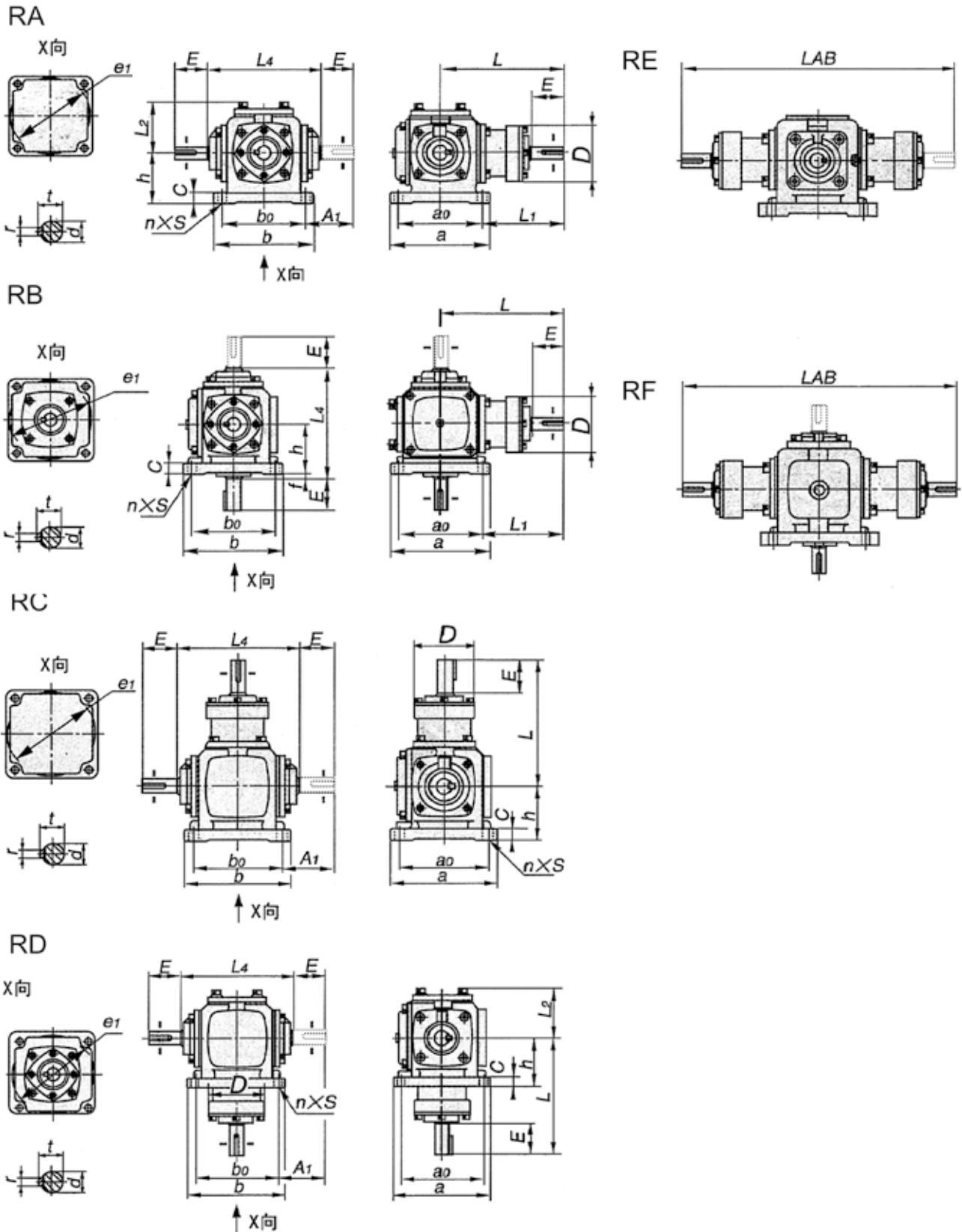



T20-T25

RA

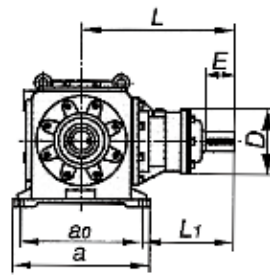
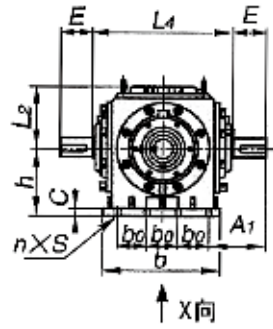

RE

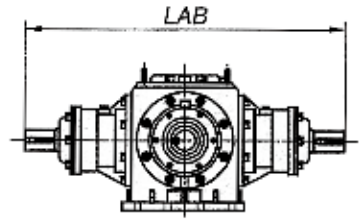

RB

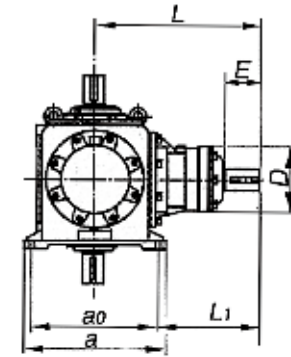
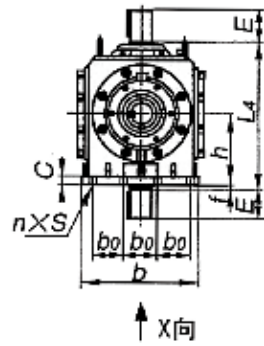

RF

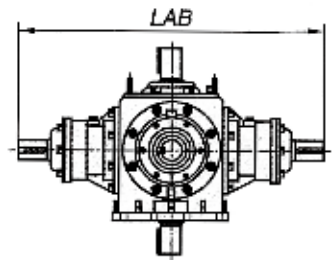

RC

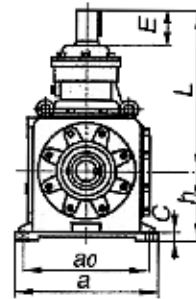
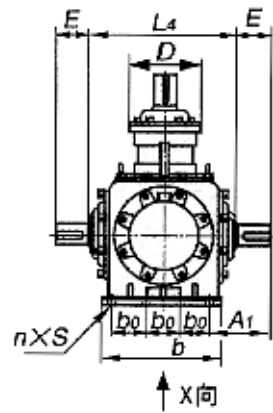
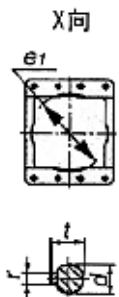

RD

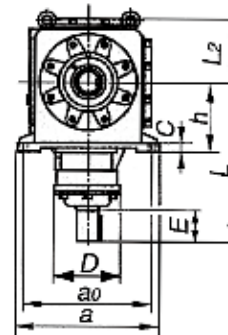
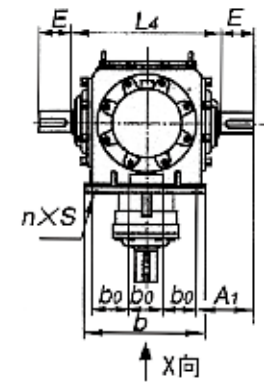



	T2	T4	T6	T7	T8	T10	T12	T16	T20	T25
A1	48	53.5	81	88	110.5	120	130	150	195	235
a	100	155	190	210	235	285	340	390	490	580
a0	84	125	152	174	195	240	290	330	430	520
b	100	155	190	210	235	285	340	390	410	480
b0	84	125	152	174	195	240	290	330	110	130
c	10	17	17	20	23	25	32	40	32	35
D	58	76	115	125	159	155	168	193	220	270
d _(h7)	15	19	25	32	40	45	50	60	72	85
E	33	38	50	62	75	90	100	105	105	130
e _{1(H8)} × 深	94 × 3	155 × 5	190 × 5	220 × 5	250 × 5	305 × 5	370 × 5	420 × 7	360 × 10	430 × 10
f	5	2	17	13	18	10	0	10	10	10
h	52	76	90	100	115	140	175	200	245	290
L	124	180	222	265	308	360	415	455	545	660
L ₁	82	117.5	146	178	210.5	240	270	290	330	400
L ₂	52	76	87	99	114.5	133	160	186	217	255
L ₄	114	156	214	226	266	300	350	420	510	600
LAB	/	360	444	530	616	720	830	/	/	/
n	4	4	4	4	4	4	4	4	8	8
r	5	6	8	10	12	14	14	18	20	22
S	9	10.5	14	14	14	16	21	25	21	24
t	17	21.5	28	35	43	48.5	53.5	64	76.5	90

注意：当速比是4:1和5:1时，纵轴尺寸不变，横轴尺寸更改如下

Note: When ratio is 4:1 and 5:1, dimension of output shaft is changeless, but that of input is changed as follows

		T6	T7	T8	T10	T12	T16	T20	T25
4:1	d _(h7)	19	22	28	32	36	50	55	70
	E	38	50	62	62	75	100	105	105
	L	210	265	310	362	415	465	560	660
	L ₁	134	178	212.5	242	270	300	345	400
	L _{AB}	420	530	620	724	830	/	/	/
	r	6	6	8	10	10	14	16	20
t	21.5	24.5	31	35	39	53.5	59	74.5	
5:1	d _(h7)	19	22	28	32	36	42	50	60
	E	38	50	62	62	75	90	100	105
	L	210	265	310	362	415	465	555	670
	L ₁	134	178	212.5	242	270	300	340	410
	L _{AB}	420	530	620	724	830	/	/	/
	r	6	6	8	10	10	12	14	18
t	21.5	24.5	31	35	39	45	53.5	64	